

HOLDPEAK 3310B

Series Scope Meter

User's Manual

SAFETY AND WARNINGS

ET310B digital storage usb and design of IEC1010 with wavelet table 1 - safety norms, over-voltage electric measurement category III - 1000V CAT, pollution protection level: 1.

CAUTION	The rules listed below should be carefully followed for safe operation.
----------------	---

1. **NEVER** apply voltage or current to the meter that exceeds the specified maximum for the function selected.

Function	Input Jacks	Maximum Input
V DC	V/ Ω , COM	1000Vp, within 10 seconds
V AC	V/ Ω , COM	700V AC RMS, within 10 seconds
mA AC/ DC	400mA, COM	500mA DC/AC RMS, Fused
A AC/ DC	20A, COM	20A DC/AC RMS, within 30 seconds with a 15 minutes cool down period
Ω	V/ Ω , COM	250V DC + AC peak, within 10 seconds
Diode	V/ Ω , COM	250V DC + AC peak, within 10 seconds
Capacitance	V/ Ω , COM	250V DC + AC peak, within 10 seconds

2. Keep the meter leads away from the testing point when changing the measuring functions.

3. Pay attention to the warning given by the meter at the top of the LCD: the warning symbol "⚡", when the input voltage exceeds the safety voltage (36V DC or 25V AC) and the high voltage icon "⚡" if the voltage reaches 600V(DC+AC peak).

4. **DO NOT** measure voltage if the voltage on the "COM" input jack exceeds 500V above earth ground.

5. **DO NOT** measure AC current on any circuit whose voltage exceeds 250V AC.

6. **NEVER** connect the meter leads across a voltage source while the function selection is in the current, resistance, diode or Capacitance mode.

7. **ALWAYS** discharge capacitors in power supplies and disconnect the power when making resistance or diode tests.

8. **ALWAYS** turn off the power and disconnect the test leads before opening the back cover to replace the fuse.

9. **NEVER** operate the meter unless the back cover is in place and fastened securely.

The International Safety Symbols





	This symbol, adjacent to another symbol or terminal, indicates the user must refer to the manual for further information.
	This symbol adjacent to one or more terminals identifies them as being associated with ranges that may, in normal use, be subjected to particularly hazardous voltages. For maximum safety, the test leads should not be handled when these terminals are energized.
	Double Insulation (Protection Class)
	This symbol advises the user that the terminal(s) so marked must not be connected to a circuit point at which the voltage, with respect to earth ground, exceeds (in this case) 500 VAC or VDC.
CAUTION	The CAUTION symbol indicated a potentially hazardous situation which, if not avoided, may result in minor or moderate injury
WARNING	The WARNING symbol indicates a potentially hazardous situation which, if not avoided, could result in serious injury or death

Table of Contents

SAFETY AND WARNINGS	0
INTRODUCTION	3
<i>Features</i>	3
<i>Survey of the Keys</i>	3
BASIC OPERATION.....	4
<i>Power On and Off</i>	4
<i>Auto Power Off</i>	4
<i>Backlight</i>	4
<i>Battery Level Indicator</i>	4
<i>Battery Charge</i>	4
<i>The Use of AC Adapter</i>	4
<i>Reset the Instrument</i>	5
DMM OPERATION	5
<i>Select DMM Mode</i>	5
<i>Basic Displays of the DMM Mode</i>	5
<i>Select the Function of DMM</i>	5
<i>Auto/Manual Range Selection</i>	6
<i>Data Hold</i>	6
<i>AC and DC Voltage</i>	6
<i>dB Display</i>	7
<i>AC and DC Current (400mA, 20A)</i>	7
<i>Frequency Counter and Duty Cycle</i>	7
<i>Resistance and Conductivity</i>	8
<i>Continuity</i>	8
<i>Diode Test</i>	8
<i>Capacitance</i>	9
<i>Relative Mode</i>	9
<i>Peak Hold (P-H) Mode</i>	9
<i>Communication in DMM mode</i>	10
<i>Save and Recall the Data of Measurement</i>	10

<i>Communication in DMM database</i>	11
DSO OPERATION	11
<i>Select DSO Mode</i>	11
<i>Basic Displays of the DSO Mode</i>	11
<i>Function Keys and Main Menu</i>	11
<i>Input Coupling Select</i>	12
<i>Time Base Control</i>	12
<i>Horizontal Position Adjustment</i>	12
<i>Vertical Scale Adjustment</i>	12
<i>Vertical Position Adjustment</i>	12
<i>Trigger Control</i>	13
<i>Trigger Level Adjustment</i>	13
<i>About the Trigger Modes</i>	13
<i>Indication of trigger Status</i>	13
<i>Capturing a Single-Shot Signal</i>	13
<i>Cursor Readout Function</i>	14
<i>Auto Measurement</i>	15
<i>AUTOSET Function</i>	15
<i>Waveform Freeze</i>	15
<i>Communication in DSO mode</i>	16
<i>Save and Recall the Waveforms</i>	16
<i>Communication in DSO database</i>	17
SETUP AND ZERO-VOLT CALIBRATION	18
TECHNICAL SPECIFICATIONS.....	19
<i>General Specifications</i>	19
<i>Digital Storage Oscilloscope</i>	19
<i>Digital Multimeter</i>	20
<i>Display Symbols</i>	21
MAINTENANCE.....	23
TROUBLESHOOTING.....	25
INSTRUMENT SET AND OPTIONS.....	25

INTRODUCTION

Features

- Combination of a 4000 count auto-range True RMS DMM and a handheld Digital Storage Oscilloscope at the size and the cost of a multimeter
- DMM functions include True RMS AC/DC voltage and current, resistance, capacitance, frequency, duty cycle, dBm, diode and continuity tests
- Full auto set up for volt/div and time/div of DSO
- Auto/normal/single DSO
- DSO Auto measure: Vpp, Vavg, Vrms, dBm
- DSO Cursor readout: dV, dt, 1/dt (frequency)
- Screen hold function
- Save and recall up to 100 waveform and data
- High contrast FSTN LCD with white LED backlight
- Auto power off in 5~60min or continuous on
- Inner Polymer Li-Ion Battery with AC adapter
- Isolated USB/RS232 interface with PC

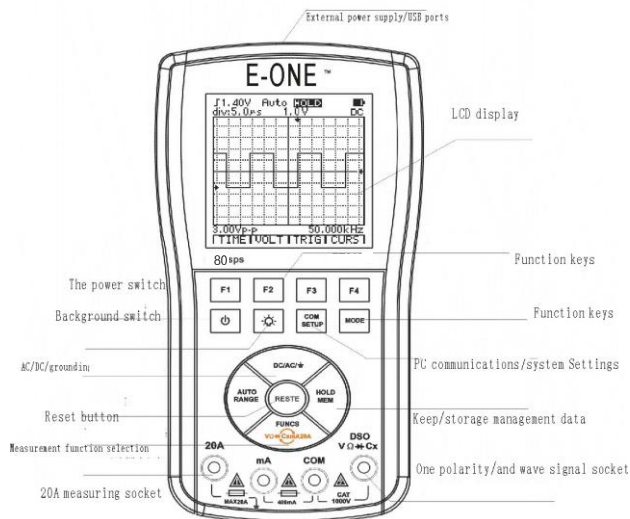

Survey of the Keys

Keys	Name	Function
		PC communications interface control and system Settings/zero adjustment of options
		Turns the instrument of or off.
		Activates the backlight, toggles the backlight on/off.
	MODE	Toggles the operation mode of DMM/DSO
	F1 ~ F4	Perform the function indicated on the LCD display.
	FUNCS.	DMM selection function (voltage/resistance/hige/diode/capacitance/current) / ADP mode (temperature/transistor/crystals/external clamp head measuring), DSO automatic measurement project selection (Vp, Vavg, Vrms - p, dBm)
	AUTO / RANGE	DMM automatically or manually choose range, automatic Settings, DSO zero self-adjustment
	DC/AC/ ±	Choose the dc/ac measurement DMM DSO or the input coupling
	HOLD/MEM	Maintain current measurement data or entering/exit data storage management functions
(on the rear of the instrument)	RESET	Rests the system.

BASIC OPERATION

Power On and Off

Pressing and holding the Power switch  for 2 seconds will turn the instrument on. Pressing and holding this button for 2 seconds again will turn the power off.

CAUTION	<ul style="list-style-type: none"> • Before turning off the power, please keep the probe away from the testing point. • Always remember to turn off the power in time after using the instrument.
----------------	---

Auto Power Off

If the meter idles for a certain time, the instrument will automatically shut off. The time of AUTO POWER OFF can be adjusted in the SETUP function. When AC power supply is used, this function will be suspended automatically.

To protect the rechargeable battery from over discharge, the instrument will automatic shut-down when the battery runs out.

Backlight

Backlighting improves the LCD effect in dark environment. Extended use of backlighting will reduce the battery life. This meter has 3 levels of brightness for users to choose.

1. Press the backlight control button  to turn on the backlight and the luminance will be getting higher one step per 0.5 seconds. If the button released at any bright level, the backlight will keep this luminance.
2. After a certain time, the backlight will shut off automatically. With the SETUP function the time of backlight auto off can be changed.
3. To turn the backlight off manually, press this button again.

Battery Level Indicator

If the meter runs with the inner battery, there is an icon on the upper right corner of LCD to indicate the battery level. User can estimate the left time of the battery with this indicator.

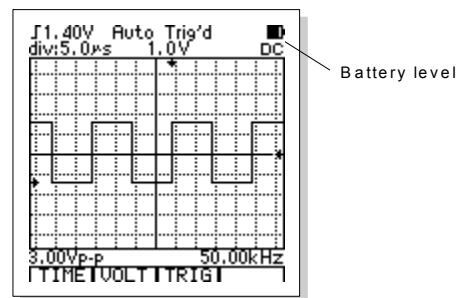

Battery Charge

The inner polymer Li-Ion battery will be automatically recharged when the AC Adapter is connected.

If the AC Adapter is connected when the meter is off, it will enter charge function directly and display the progress of charging. When the rate of progress reaches 100%, the charging is done. No matter the charging is finished or not, when the AC adapter is cut off, the meter will turn off automatically.

There are only two buttons can be used in charging function, the power button, to turn on the meter, and the backlight button, to control the backlight.

If the AC Adapter is connected when the meter is on, power form the AC adapter will not only charges the battery but also keeps the meter operating.

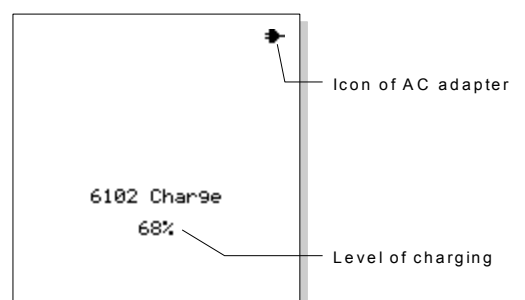

The Use of AC Adapter

The major function of AC adapter is changing the inner battery of the meter, but it can also be the power supplier of the meter. Under this condition, the power in the battery is not consumed. The AC adapter can be used whether the meter is on or off. If the AC adapter connected to the instrument, when the instrument is on, it will keep the meter operation and the only difference is the battery level indicator becomes the icon of AC adapter. If the meter is off, when the AC adapter connected, the meter will enter charge function. If turn on the meter at charge function, the meter will operate as usual.

Turning off the meter, when using AC adapter to supply power, the meter will return to

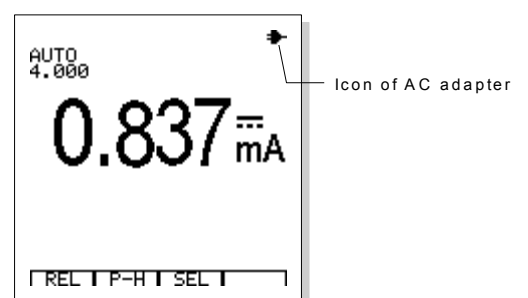

charge function until the AC adapter is disconnected. So, to make the meter turned off completely, the AC adapter would be cut off.

CAUTION	Using AC adapter for power supply may decrease safety performance of the instrument and introduce more electromagnetic disturbance. So, operating the instrument with the inner lithium battery is recommended for better Security and the best performance.
----------------	--

WARNING	DO NOT measure Volts over 250VAC or 360VDC with the power supply of AC adapter. That may cause the instrument damage permanently, even endanger user's safety.
----------------	---

Reset the Instrument

In case of unusual behaviors of the keypad or the display, it is possible to reactivate the instrument by using the **RESET** function. Press the sunken **RESET** push button at the rear of the instrument and it will subsequently return to the manufacturer-programmed setup.

CAUTION	When you press the RESET push button, DO NOT use a sharp tool!
----------------	---

DMM OPERATION

Select DMM Mode

Push the button of MODE to select digital multimeter (DSO) mode.

WARNING	<ul style="list-style-type: none"> The rules listed below should be carefully followed for safe operation. To adapt to the need of high quality test, user can choose high frequency conversion and ADP08 shielding test line joints. Shielding type test line voltage is only \square 250Vp - p, use shielding type test line should be paid attention to the voltage signal shall not exceed the voltage range.
----------------	--

Basic Displays of the DMM Mode

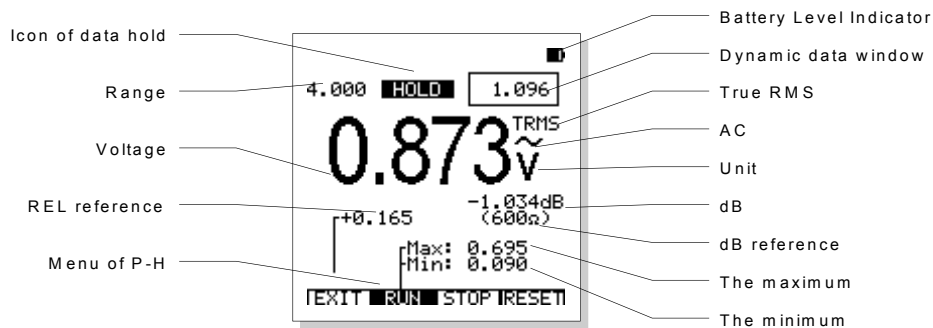

Select the Function of DMM

The push button FUNCS selects the function of DMM in the following order: VOLTAGE (DC/AC) → RESISTANT (conductance, diode, continuity) → CAPACITANCE → mA CURRENT (DC/AC) → A CURRENT (DC/AC) → VOLTAGE (DC/AC) →.....

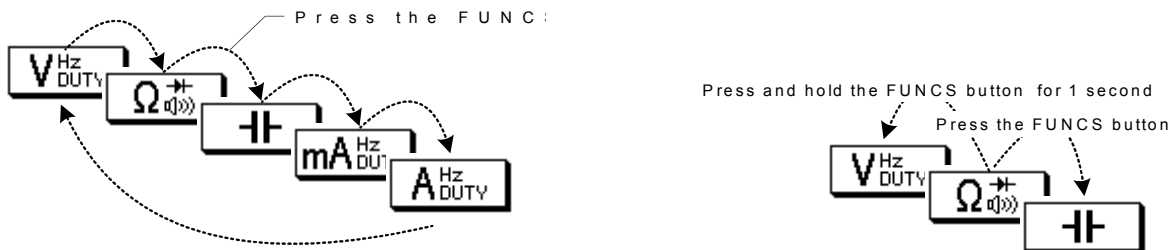

Each time the button FUNCS pressed, the next function will be selected in that order. To select the function inverse the order, press and hold the button for 1 second.

Auto/Manual Range Selection

The meter will turn on in the auto ranging mode. For most application this is the easiest and most accurate method of measurement. For measurements that require the range to be held:

1. Press the **AUTO/RANGE** key. The symbol "AUTO" will disappear and the meter is in manual range mode.
2. Each time the **AUTO/RANGE** key pressed, the next available range will be set.
3. To return the AUTO range, hold the **AUTO/RANGE** key for at least 2 seconds.

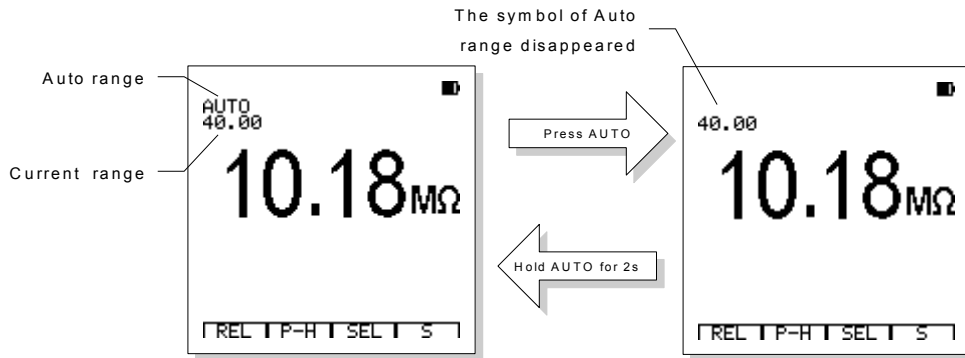

Data Hold

The meter will freeze the displayed reading when the "HOLD/MEM" key is pressed. The icon of "HOLD" will appear in LCD when HOLD is active. Press "HOLD" again to resume normal operation.

1. If HOLD is active, push and hold the key **HOLD/MEN** for 2 seconds to enter database function and the data can be saved.
2. In HOLD mode, the data in the Dynamic Data Window, a small window on the right top of the LCD, will keep live.
3. Actuation of the HOLD mode automatically switches the meter to manual ranging.
4. With the changing of the function or the range, the meter will quit the HOLD mode.

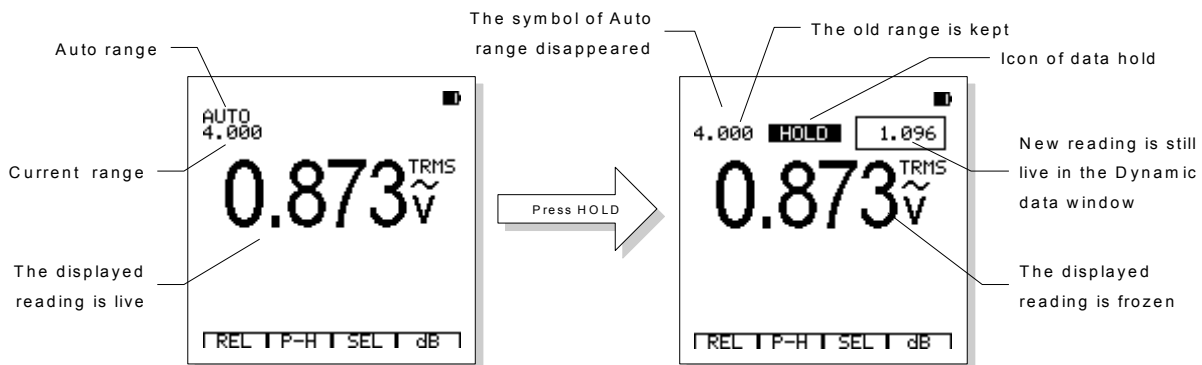

AC and DC Voltage

CAUTION To avoid meter damage, do not apply 700V AC or 1000V DC for more than 10 seconds.

1. Insert the black test lead banana plug into the negative **COM** jack and the red test lead banana plug into the positive **V** jack.
2. Set the measuring function to the  with the button **FUNCS**.
3. Press the AC/DC key to toggle between AC and DC measurements (default is DC).
4. Touch the test probe tips to the circuit under test.
5. Read the voltage in the display. The display will indicate the proper decimal point, value and appropriate symbols.

The menu of voltage function is as follow:

Relative mode	Peak hold (P-H)	Extended functions	dB Display
REL	P-H	SEL	dB
F1	F2	F3	F4

- Push **F1 (REL)** to enter the relative mode.
- Push **F2 (P-H)** to enter the peak hold mode.
- Push **F3 (SEL)** to select the extended functions: Frequency Counter and Duty Cycle.
- If in AC mode, Push **F4 (dB)** to display the dB volume of the voltage.

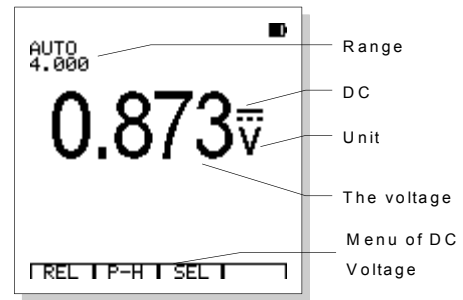

dB Display

In the AC V function, Push the function key **F4 (dB)** to display the dB volume of the voltage with the reference impedance. The “dB” symbol will appear as white on black when this feature is active.

The algorithm of dB is dBm, the 1 mW at 600 Ohms reference impedance as the 0dB. The reference impedance can be selected with the **SETUP** function.

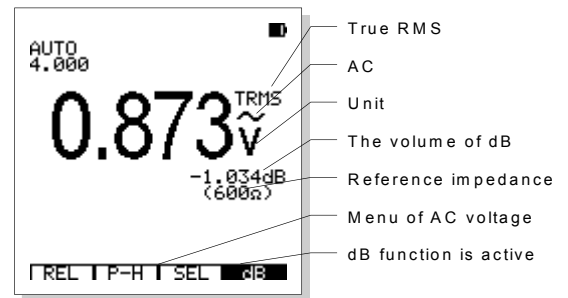



AC and DC Current (400mA, 20A)

WARNING To avoid electric shock do not measure AC current on any circuit whose voltage exceeds 250V AC.

CAUTION Do not make current measurements on the 20A scale for longer than 30 seconds once every 15 minutes, Exceeding 30 seconds may cause damage to the meter and/or the test leads.

- Insert the black lead into the negative **COM** jack and the red test lead into the positive **400mA** or **20A** jack.

- Set the measuring function to the  or  with the button **FUNCS**.
- Press the AC/DC key to toggle between AC and DC measurements (default is DC).
- Connect the test probe tips in series with the circuit under test. The display will indicate the proper decimal point, value and symbol.

The menu of current function is as follow:

Relative mode	Peak hold (P-H)	Extended functions	
REL	P-H	SEL	
F1	F2	F3	F4

- Push **F1 (REL)** to enter the relative mode.
- Push **F2 (P-H)** to enter the peak hold mode.
- Push **F3 (SEL)** to select the extended functions: Frequency Counter or Duty Cycle.

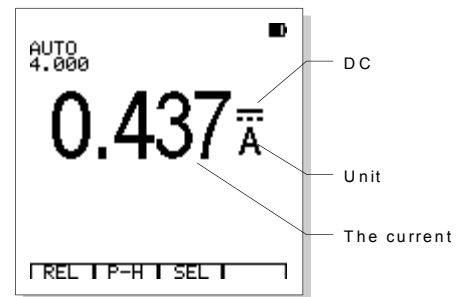

Frequency Counter and Duty Cycle

The frequency counter and duty cycle function are the extended functions of AC/DC voltage and current function.

- Insert the black test Lead into the negative (COM) jack and red test lead into the positive **V** or **400mA** or **20A** jack.
- Push the button of **FUNCS** to select the desired function and read the volume of voltage or current with auto range mode.
- Press the **F3 (SEL)** key to select the extended functions: Frequency Counter or Duty Cycle function.

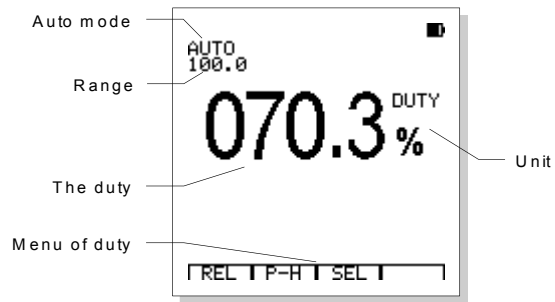
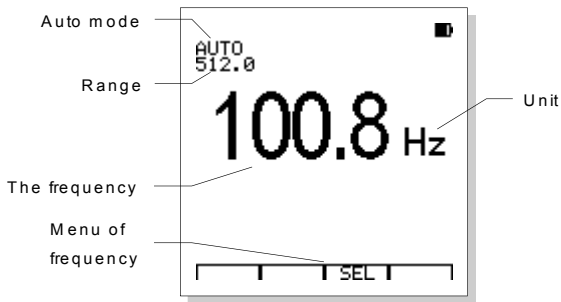

CAUTION Manual ranging and the REL and P-H modes are not available in the Frequency Counter function.

Resistance and Conductivity

WARNING To avoid electric shock while taking any resistance measurements, disconnect power to the unit under test and discharge all capacitors. Remove the batteries and unplug the line cords.

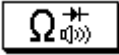
1. Insert the black test lead into the negative **COM** jack and the red test lead into the positive **Ω** jack.
2. Set the measuring function to the  with the button **FUNCS**.
3. Touch the test probe tips across the circuit or part under test. It is best to disconnect one side of the part under test so the rest of the circuit will not interfere with the resistance reading.
4. Read the resistance in the display. The display will indicate the proper decimal point, value and units.

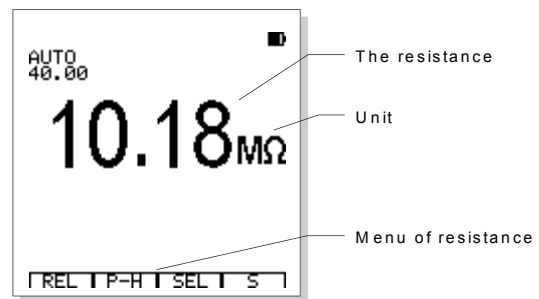

The menu of resistance function is as follow:

Relative mode	Peak hold	Extended functions	S Display
REL	P-H	SEL	S
F1	F2	F3	F4

- a. Push **F1 (REL)** to enter the relative mode.
- b. Push **F2 (P-H)** to enter the peak hold mode.
- c. Push **F3 (SEL)** to select the extended functions of Continuity and Diode Test.
- d. Push **F4 (S)** to display the conductivity.

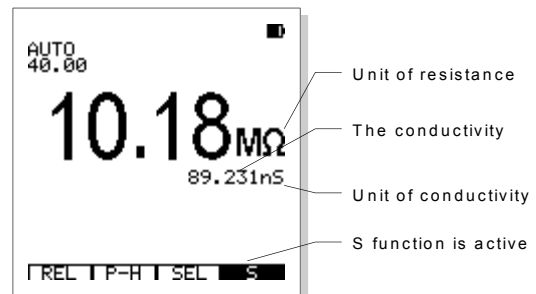

Continuity

WARNING To avoid electric shock, never measure continuity on circuits or wires that have voltage on them.

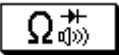
1. Insert the black test lead banana plug into the negative **COM** jack and the red test lead banana plug into the positive **Ω** jack.
2. Set the measuring function to the  with the button **FUNCS**.
3. Press the **F3 (SEL)** key to select the Continuity function.
4. Touch the test probe tips to the circuit or wire you wish to check. If the resistance is less than 30Ω, the audible signal will sound.

Diode Test

WARNING To avoid electric shock, do not test any diode that has voltage on it.

1. Insert the black test lead banana plug into the negative **COM** jack and the red test lead banana plug into the positive **Ω** jack.

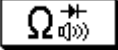
2. Set the measuring function to the  with the button **FUNCS**.
3. Press the **F3 (SEL)** key to select the Diode function.
4. Touch the test probe tips to the diode or semiconductor junction you wish to test. Note the meter reading.
5. Reverse the probes polarity by switching probe position. Note this reading.
6. The diode or junction can be evaluated as follows:
 - If one reading shows a voltage value (approximately 0.2V to 0.7V) and the other reading shows "OVER" the diode is good.
 - If both reading show "OVER", the device is open.
 - If both reading are very small or 0, the device is shorted.

Capacitance

WARNING	To avoid electric shock, disconnect power to the unit under test and discharge all capacitors before taking any capacitance measurements. Remove the batteries and unplug the line cords.
----------------	---

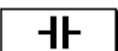
1. Insert the black test lead into the negative **COM** jack and the red test lead into the positive **CAP** jack.
2. Set the measuring function to the  with the button **FUNCS**.
3. The meter will turn on in the capacitance auto rang mode.
4. Touch the test lead to the capacitor to be tested. The display will indicate proper decimal point, value and unit.

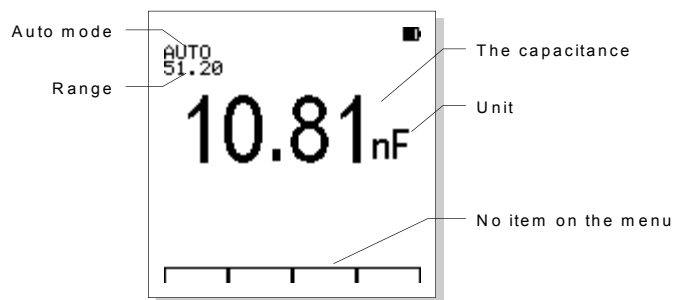

CAUTION	Manual ranging and the REL and P-H mode are not available in the capacitance function!
----------------	--

Relative Mode

The Relative feature (available in most functions) displays the difference between a stored reference value and the actual measured value.

1. When the function key **F1 (REL)** is pressed the value in the display is stored as the reference value and the relative mode is active.
2. The "REL" label will appear as white on black and reference value is displayed to indicate the mode is active.
3. The displayed value will be the difference between the stored reference value and the measured value.
4. Press the **F1 (REL)** to exit relative mode.
5. Actuation of the relative mode automatically switches the meter to manual ranging.
6. When function or range changed, the relative mode will end automatically.

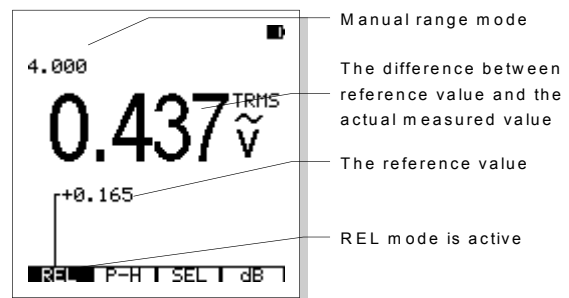

Peak Hold (P-H) Mode

The Peak Hold feature (available in most of the functions) displays the Maximum and Minimum measured values. The data is updated every 400ms.

Press the function key **F2 (P-H)** to enter this function and the LCD will display the peak value of the measured data: the peak maximum and peak minimum values.

The menu of Peak Hold mode is as follow:

Exit Peak Hold mode	Run the measurement	Stop the measurement	Reset the volumes
EXIT	RUN	STOP	RESET

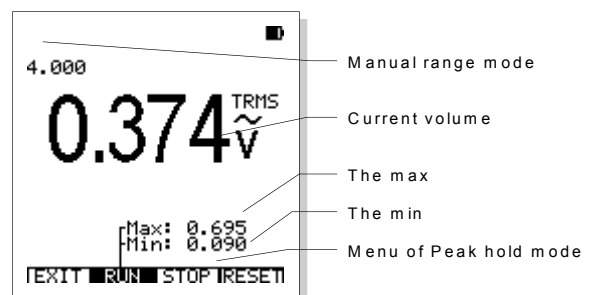

F1 **F2** **F3** **F4**

- Press **F1 (EXIT)** to exit the Peak Hold mode.
- Press **F2 (RUN)** to run the Peak Hold measuring.
- Press **F3 (STOP)** to hold the MIN/MAX values.
- Press **F4 (RESET)** to reset the peak values for a new run.

NOTE	<ul style="list-style-type: none"> Actuation of the Peak Hold function automatically switches the meter to manual ranging When function or range changed or select the relative mode, the Peak Hold mode will end automatically.
-------------	--

Communication in DMM mode

Communication in DMM mode can upload current results to PC.

- Press the key of COM/SETUP to start the communication between meter and PC and the icon of  will be displayed on meter's LCD screen. Press that key again the communication will be stop and the icon disappear.
- After the starting of communication, the digits and their units on LCD will display on the DMM digits window of PC310A completely similarly but lags a while for the upload. Those digits can be recorded, saved and printed.
- In the course of communication, PC310A will never stop renew the digits even the meter in data HOLD status. If the meter displays digits in relative mode, the PC310A also displays relative volume. And the P-H, conductivity, dB etc. will not be displayed on PC310A.

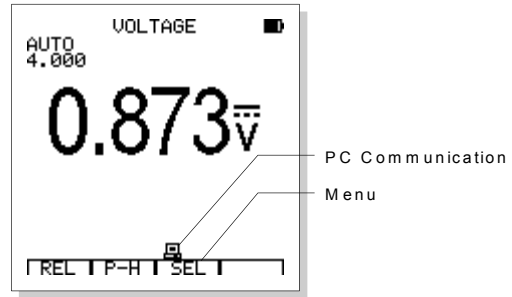

NOTE	Communication function has no time limit. But when communication, because the RS232/USB cable occupied AC adaptor jack, meter cannot use the external power supply, the communication time is limited by the battery capacity.
-------------	--

NOTE	About other operations of scope meter please refer to the User's Manual of ET310B series.
-------------	---

Save and Recall the Data of Measurement

In the DATABASE of this meter, 100 data of DMM measurement can be saved in memory.

- Press and hold the **HOLD/MEN** key for 2 seconds to enter database feature.
- If you want to save the current data of measurement, press the **HOLD/MEN** key to HOLD it and then enter database by Pressing and holding the **HOLD/MEN** key for 2 seconds.
- The LCD will list the first 10 (the first page) memory locations and indicates if the data is stored or not in each location.
- If the data is stored in the selected memory location, the stored data and its unit will be listed.

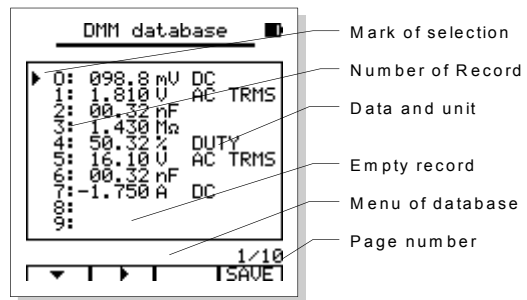

The menu of DATABASE function is as follow:

Select a record	select the adjacent pages		Save the frozen data
▼	▶		SAVE

F1 **F2** **F3** **F4**

- Press **F1 (▼)** to select the memory location within the current page. Each time you press the F1, the selection will be changed to the next. Press and hold the F1 for at least 0.5 seconds, when the icon of F1 becomes "▲", the previous memory location will be selected.
- Press **F2 (▶)** to select the adjacent page. Each time you press the F2, the page will be changed to the next. Press and hold the F2 for at least 0.5 seconds, when the icon of F1 becomes "◀", the previous page will be selected.
- Press **F4 (SAVE)** the frozen data will be saved in the selected memory location.

NOTE	If you want to save the current data of measurement, HOLD it first. If not, the label of F4 (SAVE) will not appear.
-------------	---

CAUTION	If a new data is saved in a memory location which has already a data, the old data will be replaced by the new one. Pay attention when saving a new data, to avoid the losing of valuable information.
----------------	--

5. Press the button **HOLD/MEN** again to exit the DATABASE function.

Communication in DMM database

With communication function in DMM database, user can upload all data to PC completely. The method is as follows:

1. Press the key of COM/SETUP in database mode to start the communication between the meter and PC and upload the information of database.
2. When data transport start, the LCD will display the icon of communication and progress of upload. The complete upload process probably needs ten seconds.
3. Once the progress reaches 100%, upload done and icon disappear.
4. Press the key of COM/SETUP again will initiate data upload once more.

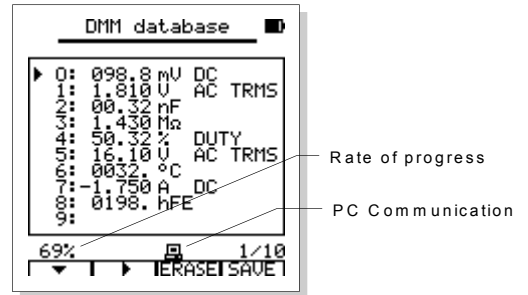

NOTE	Before upload start, user might clear the DMM data record window of PC61 to get a 'clear' list of the meter's database.
-------------	---

DSO OPERATION

Select DSO Mode

Push the button of MODE to select digital storage oscilloscope (DSO) mode.

NOTE	Because the test leads and probe of the multimeter has no Shield, so it is difficult to keep the signal from disturbance radically. Please contact the distributor on the shield test leads for the situation of high quality measurement.
-------------	--

Basic Displays of the DSO Mode

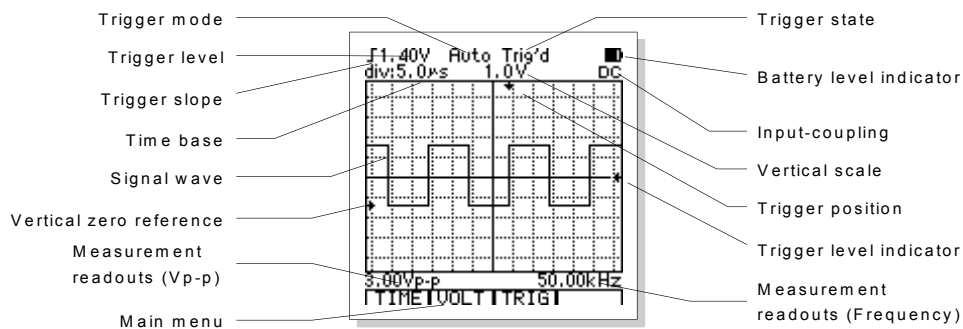

Function Keys and Main Menu

The function keys are located directly below the LCD and perform multiple operations as indicated by the menu on the LCD. Some functions will produce a sub-menu on the LCD for further selection. Operation of the menus and sub-menus is described in the appropriate operation paragraph.

The main menu indicates the basic operations as follow.

Time base	Vertical scale	Trigger	Cursor
TIME	VOLT	TRIG	CURS
F1	F2	F3	F4

1. **F1 (TIME)** enters the time base submenu to change the time base and horizontal position of the waveform.
2. **F2 (VOLT)** enters the vertical scale submenu to change the vertical scale and vertical position of the waveform.
3. **F3 (TRIG)** enters the trigger control submenu to change the trigger level, slope and mode.
4. **F4 (CURS)** enters cursor readout submenu. This function is effective only when waveform is frozen (by HOLD or single trigger).

Input Coupling Select

Input coupling determines what part of the signal passes on to the oscilloscope. Coupling types include DC, AC and GND.

DC Coupling A mode that passes both AC and DC signal components to the circuit.

AC Coupling A mode that blocks the DC component of a signal but passes the dynamic (AC) component of the signal.

GND Coupling Use GND (\perp) coupling to display a zero-volt waveform. When you use GND coupling, the input signal is not sent to the internal circuits. Internally, the input is connected to a zero-volt reference level.

Time Base Control

At main menu, Press **F1 (TIME)** to enter the time base submenu.

Return to main menu	Time base adjustment		Enter Position submenu
EXIT	◀	▶	POS
F1	F2	F3	F4

1. Press **F1 (EXIT)** to return to the main menu.
2. Press **F2 (◀)** or **F3 (▶)** to adjust horizontal division (t/div).
3. Press **F4 (POS)** to enter horizontal position adjusting submenu.

CAUTION	Use the minimum time base as a starting point when measuring a signal which's frequency is unknown and select longer time bases until the signal is displayed properly. Otherwise the display may not correctly reflect the signal under measurement due to aliasing.
----------------	--

NOTE	There are various ways to prevent aliasing: adjust the horizontal scale or push the AUTO/RANG button.
-------------	---

Horizontal Position Adjustment

At the time base submenu, Press **F4 (POS)** to enter the horizontal position submenu.

Return to time base submenu	Horizontal position adjustment		Set trigger position to the centre
EXIT	◀	▶	RESET
F1	F2	F3	F4

1. Press **F1 (EXIT)** to return to the time base submenu.
2. Press **F2 (◀)** or **F3 (▶)** to move the waveform.
3. Press **F4 (RESET)** to move the trigger position to the horizontal centre of the screen.

Vertical Scale Adjustment

At main menu, Press **F2 (VOLT)** to enter the vertical adjusting submenu.

Return to main menu	Vertical scale adjustment		Enter Position submenu
EXIT	◀	▶	POS
F1	F2	F3	F4

1. Press **F1 (EXIT)** to return to the main menu.
2. Press **F2 (◀)** or **F3 (▶)** to adjust vertical division (V/div).
3. Press **F4 (POS)** to enter vertical position adjusting submenu.

CAUTION	In order to keep the inner circuit of the instrument stable, when you press F2 or F3 to adjust the vertical scale, the respondents of the instrument may be with a little delay.
----------------	--

Vertical Position Adjustment

At vertical adjusting submenu, Press **F4 (POS)** to enter the vertical position adjusting submenu.

Return to vertical adjusting submenu	Vertical position adjustment		Set vertical position to the centre
EXIT	▼	▲	RESET
F1	F2	F3	F4

1. Press **F1 (EXIT)** to return to the vertical adjusting submenu.
2. Press **F2 (▼)** or **F3 (▲)** to move the waveform.
3. Press **F4 (RESET)** to move the waveform to the vertical centre of the screen.

Trigger Control

At main menu, Press **F3** to change the trigger level, slope and mode.

Return to main menu	Trigger slope	Trigger mode	Trigger level adjustment
EXIT	┌ └	MODE	LEVEL
F1	F2	F3	F4

1. Press **F1 (EXIT)** to return to the main menu.
2. Press **F2 (┌ └)** to toggle the rising edge"┌" and falling edge"└".
3. Press **F3 (MODE)** to select trigger mode.
4. Press **F4 (LEVEL)** to enter the trigger level adjusting submenu.

Trigger Level Adjustment

At trigger submenu, Press **F4 (LEVEL)** to enter the trigger level adjusting submenu.

Return to trigger submenu	Trigger level adjustment		Set the trigger level to zero
EXIT	▼	▲	RESET
F1	F2	F3	F4

1. Press **F1 (EXIT)** to return to the trigger submenu.
2. Press **F2 (▼)** or **F3 (▲)** to adjust the trigger level.
3. Press **F4 (RESET)** to set the trigger level to zero.

About the Trigger Modes

Auto. This trigger mode allows the oscilloscope to acquire a waveform even when it does not detect a trigger condition. If no trigger condition occurs while the oscilloscope waits for a specific period, it will force itself to trigger. When forcing invalid triggers, the oscilloscope cannot synchronize the waveform, and the waveform seems to roll across the display. If valid triggers occur, the display becomes stable on the screen. User can use Auto mode to monitor the low frequency irregular signal or the amplitude level, such as a DC power supply output etc.

Normal. The Normal mode allows the oscilloscope to acquire a waveform only when it is triggered. If no trigger occurs, the oscilloscope will not acquire a new waveform, and the previous waveform, if any, will remain on the display.

Single. The Single mode allows the oscilloscope to acquire one waveform each time you press the HOLD/MEM button, and the trigger condition is detected. After the acquisition of a new waveform, the waveform will be frozen automatically.

Indication of trigger Status

Auto	In auto trigger mode. The oscilloscope can acquire a waveform even when it does not detect a trigger condition.
Ready	Waiting for a valid trigger.
Trig'd	The trigger condition is detected.
Acq. Complete	Acquisition completed (in Single mode).

Capturing a Single-Shot Signal

To set up for a single-shot acquisition, do these steps:

1. Adjust the vertical scale V/div and horizontal scale s/div to appropriate ranges for the signal you expect to see.
2. Select a proper trigger level, slope and the mode of **Single**.
3. If the readout at the top of the screen does not display "**Ready**", then push the HOLD/MEM button to start the acquisition. When the signal appears, the oscilloscope is triggered and captures the event.

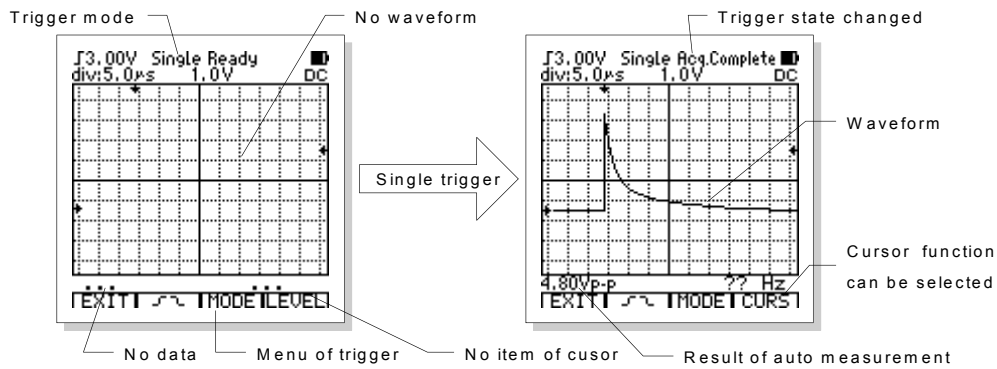

NOTE	If the single-shot waveform is hold, pushing F4 can enter cursor readout function or pushing and holding the key HOLD/MEN for 2 seconds can enter database function and then save the waveform.
-------------	--

CAUTION	If Single mode is selected, any adjustment of waveform is forbidden. If you want to change the time base, vertical scale, inputting couple mode, wave position etc. press the function key F3 (TRIG) to enable the trigger mode select (MODE) and change the trigger mode to Auto or Norm.
----------------	---

Cursor Readout Function

The cursor function measures voltage difference (ΔV) or time difference (Δt) between two cursors on the screen. Selecting ΔV will produce two horizontal cursors and selecting the Δt functions will produce two vertical cursors. The amplitude or time difference between the two cursors is displayed on the screen.

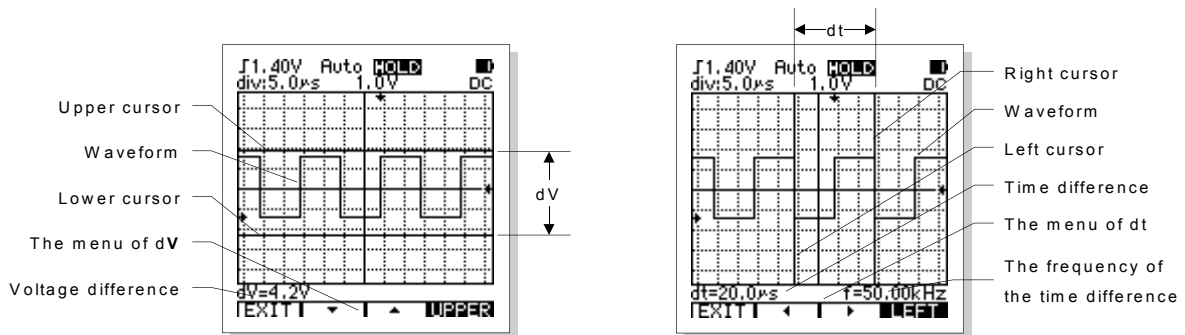

The cursor readout function is effective only when the waveform is frozen (by HOLD or single trigger). After the waveform frozen, press F4 to enter the Cursor Readout sub-menu:

Exit	Voltage difference	Time difference	
EXIT	ΔV	Δt	F4
F1	F2	F3	F4

The operation of Cursor Readout is as follow:

1. Push **F1 (EXIT)** to exit cursor readout sub-menu.
2. Push **F2 (ΔV)** to measure voltage difference and enter the ΔV submenu. The voltage difference between the upper and lower cursor can be readout. For example, measure the peak to peak voltage of the waveform.

The ΔV submenu is as follow:

Exit	Shift the cursor		Cursor select
EXIT	▼	▲	UPPER
F1	F2	F3	F4

- a. Push **F1 (EXIT)** to exit the ΔV submenu
- b. Push **F2 (▼)** or **F3 (▲)** to move the cursor down/up.

c. Push **F4** to toggle the upper/lower cursor.

3. Push **F3** (Δt) to measure time difference and enter the Δt submenu. The time difference and the frequency between the left and right cursor can be readout. For example, measure pulse width or the period/frequency of one cycle.

The Δt submenu is as follow:

Exit	Shift the cursor		Cursor select
EXIT	◀	▶	LEFT
F1	F2	F3	F4

a. Push **F1** (**EXIT**) to exit the Δt submenu

b. Push **F2** (◀) or **F3** (▶) to move the cursor left/right.

c. Push **F4** to toggle the left/right cursor.

Auto Measurement

The oscilloscope can calculate the amplitude and frequency of the waveform automatically. Because these measurements use the waveform record points, they are more accurate than visual estimate or cursor measurements.

The results of the measurement are displayed below the waveform, the amplitude at the left and the frequency at the right. The amplitude may be the peak-to-peak, average, RMS and dBm. Pushing the key **FUNCS** can select the result of amplitude measurement. These readouts are updated periodically as the oscilloscope acquires new data.

CAUTION	The results of the auto measurement are based on the calculation to the waveform displayed. Apparently, the smaller the amplitude of the waveform is, the larger the relative errors are. When the amplitude of the waveform is too small, the results will be displayed with the symbol “?” to prompt the user to understand the data correctly. On the other hand, if the signal amplitude is too large, near or passing the measuring range, the “?” will also be displayed to get users' attention.
----------------	---

AUTOSET Function

The AUTOSET function obtains a stable waveform display for you. It automatically adjusts the settings of vertical and horizontal scaling, as well as the trigger level, and mode.

You need to see a signal in a circuit, but you do not know the amplitude or frequency of the signal. You want to quickly display the signal and measure the frequency, period, and peak-to-peak amplitude. To quickly display a signal, do these steps:

1. Connect the probe to the signal.

2. Push the **AUTO/RANGE** button.

The oscilloscope sets the vertical, horizontal, and trigger-level automatically. If you want to optimize the display of the waveform, you can manually adjust these controls.

If the instrument can not find out proper scan parameters, the LCD will display “**AUTO SET fail**” and the quit the AUTOSET operation and all old scan parameters are kept.

NOTE	The AUTOSET is effective for stable cyclical signals. Because of the alias, the oscilloscope may choose wrong time base when the frequency near the limit of the instrument. User should be careful and observe if the result of AUTOSET is rational.
-------------	---

Waveform Freeze

While acquisition is running, the waveform display is live. Stopping the acquisition freezes the display. The waveform can be frozen for further observe and if you want to save the waveform, you have to hold it first. The waveform can be hold both by pressing the key of **HOLD/MEM** or with the single trigger mode.

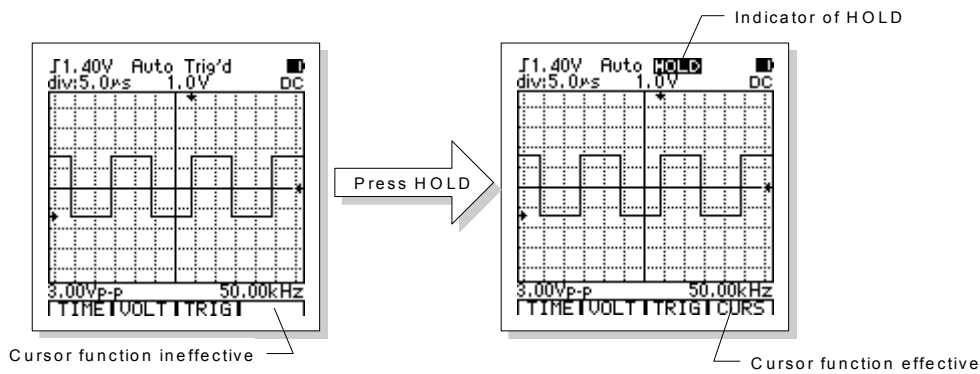

The key of **HOLD/MEM** can start and stop waveform acquisition. When the instrument has stopped acquiring waveform data, the display is frozen.

If the time-base is set at 50ms/div or faster, after pushing HOLD/MEN key, the last waveform can be frozen immediately and if the time-base is at 0.1s/div or more slowly, in rolling scan mode, the instrument will shift the oldest data to the left automatically to keep the continuity of the waveform.

NOTE	If the waveform is frozen, pushing F4 can enter cursor readout function or pushing and holding the key HOLD/MEN for 2 seconds can enter database function and then save the waveform.
caution	If the waveform is frozen, any adjustment of waveform is forbidden. If you want to change the time base, vertical scale, inputting couple mode, wave position etc. press function key HOLD/MEN to restart waveform acquisition.

Communication in DSO mode

With communication function in DSO mode, user can upload all waveform to PC.

The method is as follows:

1. Press the key of COM/SETUP to start the communication between meter and PC and the icon of  will be displayed on meter's LCD screen. Press that key again the communication will be stop and the icon disappear.
2. After the starting of communication, the waveform displayed on LCD will display on the DSO waveform window of PC61 completely similarly but lags a while for the upload. Those waveforms can be saved and printed.
3. Since a waveform upload need several seconds the rate of renew both the meter and PC61 is limited. Lower renew rate will cause the difficulty of the operation of the button on the meter. If the user wants to adjust the meter in communication, press the key COM/SETUP to stop communication first.
4. After freeze of the waveform and a single acquire complete, waveform upload will stop. In this time, whether communication started or not, press COM/SETUP key, the frozen waveform can be sent to PC. Press the key of COM/SETUP again will initiate data upload once more.

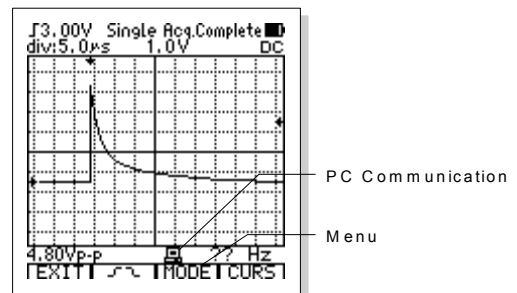

NOTE	When the meter is in slow scan status, as the scan need quite long time, the renew rate of the waveform in PC61 will also be prolonged.
------	---

Save and Recall the Waveforms

In the DATABASE mode, 100 waveforms can be saved in memory.

1. Press and hold the **HOLD/MEN** key for 2 seconds to enter the database feature.
2. If you want to save current waveform, press the **HOLD/MEN** key or use the single trigger mode to freeze the current waveform and then enter database by Pressing and holding the **HOLD/MEN** key for 2 seconds.
3. In database, the instrument will list the first 10 (the first page) memory locations and indicates if the data is stored or not in each location.

4. If there are data in the selected memory location, there will be the draft of waveform and relative parameters at the waveform browse window.
 If the selected memory locations with no data, the waveform browse window will be blank.

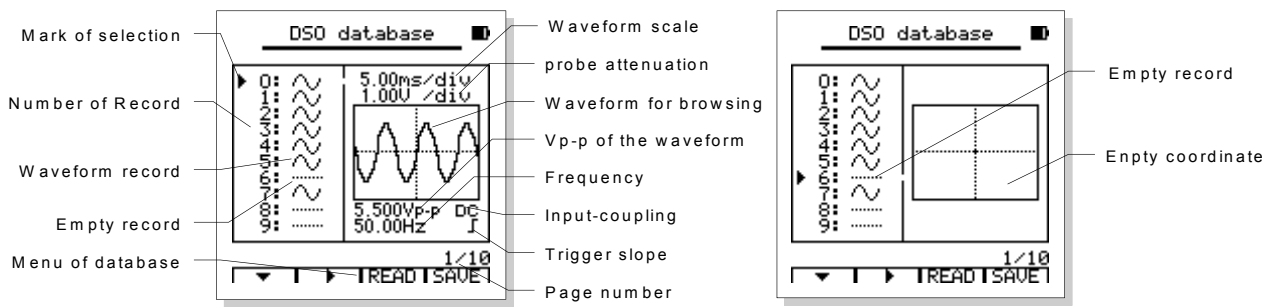

5. Press button **HOLD/MEN** to exit database function.

The menu of database function is as follow:

Select memory locations	Select adjacent pages	Read the waveform	Save the frozen waveform
▼	▶	READ	SAVE
F1	F2	F3	F4

- Press the **F1** (▼) to select the memory location within the current page. Each time you press the F1, the selection will change to the next memory location. Press and hold the F1 for at least 0.5 seconds, when the icon of F1 becomes “▲”, the previous memory location will be selected.
- Press the **F2** (▶) to select the adjacent page. Each time you press the F2, the page will change to the next. Press and hold the F2 for at least 0.5 seconds, when the icon of F1 becomes “◀”, the previous page will be selected.
- Press the **F4** (**SAVE**) to save the frozen waveform.

NOTE If you want to save current waveform, HOLD the waveform first. If not, the label of **F4** (**SAVE**) will not appear.

CAUTION If a new waveform is saved in a memory location which has already a waveform, the old waveform will be replaced by the new one. Pay attention when saving a new waveform, to avoid the losing of valuable data.

- Press the **F3** (**READ**) to recall and display the saved data.

In the waveform read function, the LCD will display the waveform and the relative parameters as follow:

The results of auto measurement are also displayed below the waveform. The amplitude may be the peak-to-peak, average, RMS and dBm. Pushing the key **FUNCS** can select the result of amplitude measurement. If the result(s) of the waveform can not be calculated, the symbol “?” will be displayed to call the attention of the user.

The menu of waveform read function is as follow:

Exit	Read previous waveform	Read next waveform	Cursor readout
EXIT	◀	▶	CURS
F1	F2	F3	F4

- Press the **F1** (**EXIT**) to exit waveform read function.
- Press the **F2** (◀) or **F3** (▶) to read previous or next waveform.
- Press the **F4** (**CURS**) to enter the cursor readout function.

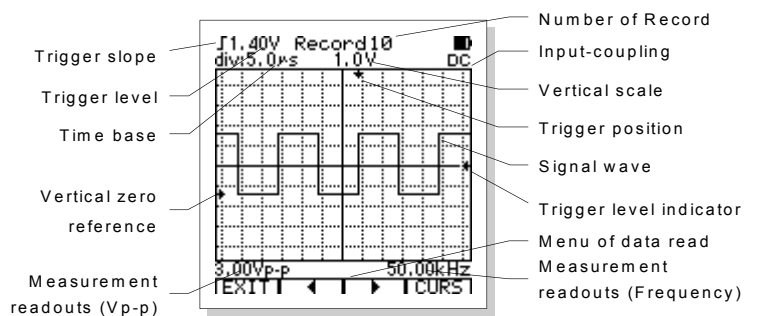

Communication in DSO database

Communication in DSO database function can upload the data in database to PC. The procedure is as follow:

1. Select the data record that you want to upload. If in preview mode, press button F1 and F2 to let the selection mark point the record. Or user can into waveform read function.
2. Press COM/SETUP button, the meter will send the selected data to PC.
3. If the mark of selection points to or READ an empty record, no data will upload.

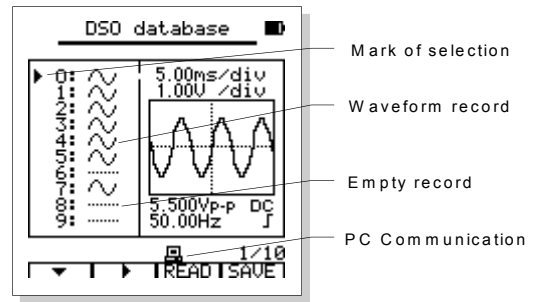

4. When upload the icon of communication will be displayed on the LCD. The upload process takes about for 5 seconds. When upload done, the icon will disappear. Press button COM/SETUP again will initiate data upload once more.

SETUP AND ZERO-VOLT CALIBRATION

Set up:

The setup function provides a means to set default conditions and the zero-calibration. Pressing and holding the button SETUP for 2 seconds will enter the setup function.

The menu of **SETUP** is as follow:

Select item	Change the desired condition		zero volt calibration
▼	◀	▶	Restore
F1	F2	F3	F4

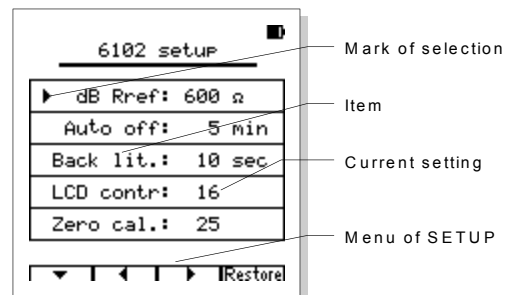

1. Press **F1** (▼) to move the selection pointer to the desired item. Each time you press the F1, the selection will change to the next item. Press and hold the F1 for at least 0.5 seconds, when the icon of F1 becomes “▲”, the previous item will be selected.
2. Press **F2** (◀) or **F3** (▶) to change the desired condition.
3. Press **F4** (Restore) to give up current selection, restore the original settings.
4. Press the button **AUTO/RANGE** to calibrate the zero-volt automatically, when the item “Zero cal” is selected.
5. Press the button **SETUP** to exit setup function.

The range of settings:

dBm Rref (Reference resistor of dBm)	2, 4, 8, 16, 50, 75, 93, 110, 125, 135, 150, 300, 600, 900, 1000, 1200(Ω)
Auto off (Delay of auto power off)	5, 10, 15, 20, 30, 40, 60 (minute), Never (Disable Auto Power Off function)
Back-lit (Delay of backlight off)	5, 10, 15, 20, 30, 40, 60, 120 (seconds)
LCD contra (LCD contrast)	0 ~ 32
Zero Cal. (Zero-volt calibration, in DSO mode)	-64 ~ +64

Zero-Volt Calibration in DSO mode:

In DSO mode, if the input voltage is 0, the instrument should display a zero-volt waveform. If the zero-volt waveform is not zero, the instrument has its zero-offset. This instrument has the function of zero-volt calibration. For checking the zero-offset of the instrument:

1. Set the meter to DSO mode and set the input coupling to DC with the vertical scale between 1V/div ~ 4V/div.

- Set the trigger mode to AUTO with the time base between 10ms/div ~ 10μs/div.
- Adjust the vertical zero reference (the mark of an arrow at left size of the coordinate) to the vertical centre of the coordinate.
- Shortcut the input lines of the probe.

At this time you can see a horizontal line (there may be small clutter on it, that's normal). This horizontal line is the zero-volt waveform. It should be at the vertical position of the vertical zero reference exactly. If not, it means zero-volt compensation is needed. If the line is 6 points below vertical zero reference (there are 10 points for each div), 6 points should be added to the present compensate volume. And if the line is 5 points above, it means 5 points should be subtracted from the present compensate volume.

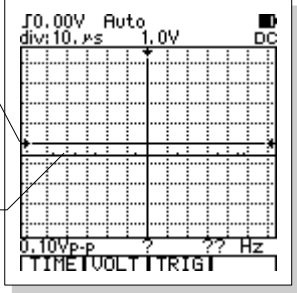
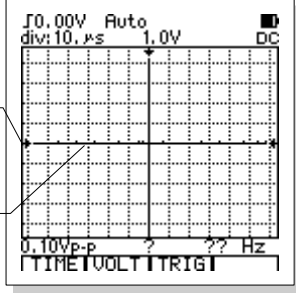
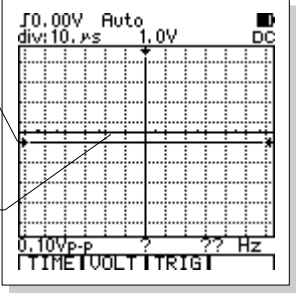
 <p>Zero reference</p> <p>Zero waveform</p> <p>0.10Vp-p ? ?? Hz</p>	 <p>Zero reference</p> <p>Zero waveform</p> <p>0.10Vp-p ? ?? Hz</p>	 <p>Zero reference</p> <p>Zero waveform</p> <p>0.10Vp-p ? ?? Hz</p>
Zero-volt waveform is 6 points below the vertical zero reference.	Zero-volt waveform is correct.	Zero-volt waveform is 5 points above the vertical zero reference

The last item of SETUP function is "Zero Cal". Select this item in SETUP function and the compensate volume can be adjusted with the keys **F2** (◀) or **F3** (▶) directly.

Besides manually adjusting, you can use the auto zero calibration function. It is quite easy: enter the setup function under DSO mode, shortcut the input probe then press the keys of AUTO/RANGE and wait for a while.

CAUTION	If you want to use the auto zero calibration function, you should select the DSO mode before entering the SETUP function, otherwise the auto zero calibration function will be not available.
----------------	---

TECHNICAL SPECIFICATIONS

General Specifications

Display	128 × 128 pixel graphic LCD	Viewing Area	71.7 mm x 71.7mm
Back Light	White LED, 3 levels of brightness	Input Impedance	10MΩ
Power	Inner Polymer Li-Ion Battery or AC adapter	Auto Power Off	5~60minutes adjustable with disable feature
Indication of low power	☐	Charging time	About 3hrs
Battery life	12~16hrs approx. (vary with different models)	Memory	100 records (both DMM data and DSO waveform)*
Operational conditions	0°C to +50°C (+32°F to +122°F); < 75%RH	Storage conditions	-10°C to +60°C (-14°F to 140°F)
Dimensions	86 mm × 186 mm × 32mm	Weight	325g (without the holster and other accessories)

* The ET310B has only 50 records.

Digital Storage Oscilloscope

Simulation bandwidth	DC ~ 20MHz (50mV/div ~ 10V/div)	Maximum real-time	80Msps
----------------------	---------------------------------	-------------------	--------

		sampling rate	
The vertical resolution	8 bits	Nonlinearity	±1 bit
Channel number	1	Coupling	DC/AC/GND
Input impedance	about 10MΩ	indexing	Vertical ± 4.8, horizontal 12.8
Vertical sensitivity range	50mV/div ~ 200V/div	When range	0.20μs/div ~ 20s/div
Vertical amplitude precision	±(5%+ 0.1div)	When the accuracy	±(0.01% + 0.1div)
Automatic zero reference	In DC/dB measurement	Scanning mode	Auto/normal/single
Trigger level	± 12 div (At each step, 0.1div)	Trigger slope	Rising along/down along
Trigger position adjustment	± 6 div (At each step, 0.1div)	Automatic Settings	When the vertical amplitude and automatic Settings
The cursor measurement function	dV, dt, 1/dt (Frequency)	Automatic measurement function	Vp-p, Vavg, RMS, dBm
Automatic measurement accuracy	±(5%+ 0.1div)	Record length	12.8div

* 10MHz refers to simulate bandwidth to 3db voltage when the attenuation of bandwidth, when the input signal interference, change with ADP08 and special high frequency shield.

* 1-2-5 for vertical attenuation switch range

Digital Multimeter

Function	Range	Resolution	Accuracy
DC Voltage	400.0mV	0.1mV	±(0.75%rdg + 10dgt)
	4.000V	1mV	
	40.00V	10mV	
	400.0V	100mV	
	1000V	1V	± (1.5%rdg + 10dgt)
AC Voltage (True RMS)	400.0mV	0.1mV	50Hz~1kHz: ±(1.0%rdg + 10dgt);
	4.000V	1mV	1kHz~10kHz: ±(2.0%rdg + 10dgt);
	40.00V	10mV	(above 10kHz not specified)
	400.0V	100mV	
	750V	1V	50Hz~1kHz : ± (1.5%rdg + 10dgt)
DC Current	40.00/400.0mA	10/100μA	±(1.2%rdg + 10dgt)
	4.000/20.00A	1/10mA	
AC Current (True RMS)	40.00/400.0mA	10/100μA	±(1.5%rdg + 10dgt)
	4.000/20.00A	1/10mA	50Hz~1kHz (above 1kHz not specified)
Resistance	400.0Ω	0.1 Ω	±(1.0%rdg + 5dgt)
	4.000K	1 Ω	
	40.00K	10 Ω	
	400.0K	100 Ω	
	4.000MΩ	1K	

	40.00M Ω	10K	\pm (3.0%rdg + 5dgt)
Capacitance	51.20nF	1pF	\pm (2%rdg + 10dgt)
	512.0nF	10pF	\pm (1%rdg + 3dgt)
	5.120 μ F	100pF	\pm (1%rdg + 3dgt)
	51.20 μ F	1nF	\pm (1.5%rdg + 3dgt)
	100.0 μ F	10nF	May need 30 sec.
Frequency Counter	5.12Hz ~ 5.12MHz	0.1Hz ~ 1kHz	\pm (1.0%rdg + 5dgt), (The signal amplitude \geq 3Vp-p, AC V or 20mA RMS, AC A)
Duty Cycle	0.1~99.9%		
Diode	Open circuit voltage 1.5 V, maximum current about 1.5mA		
Continuity	Sound when lower than 30 Ω		
Auto range	For every function		
Over range	Indicates "O. L" (Over load)		
Measurement rate	2.5 times/sec.		
Dynamic Data Window	Keep the data in the window live In hold mode.		
dB (-80 ~ +80dB) reference	2, 3, 8, 16, 50, 75, 93, 110, 125, 135, 150, 300, 600, 900, 1000, 1200 Ω		
Fuse	ϕ 5 \times 20, 0.5A/250V		

Display Symbols

A	Ampere	AC ~	Alternating current
AUTO	Auto ranging / trigger / setup	AVG, avg	Average
CURS	Cursor	dB	Decibel
DC	Direct current	div	Division
DUTY	Duty cycle	EXIT	Exit current state or menu
F	Farads(capacitance)	Hz	Hertz (frequency)
HOLD	Hold the data or waveform	LEVEL	Trigger level
LEFT	Select left cursor	LOWER	Select lower cursor
MANUA	Manual range	MAX	Maximum
mA	Mili Ampere	mF	Mili Farads (capacitance)
MIN	Minimum	ms	Millisecond
mS	Mili Siemens (conductance)	mV	Mili volt
NORM	Normal trigger mode	nF	Normal Farads (capacitance)
nS	Nano Siemens (conductance)	P-H	Peak-hold
POS	(Horizontal / vertical) position	RANGE	Range
READ	Readout saved data or waveform	READY	Ready for trigger
REL	Relative volume	RESET	Reset or set the position to the centre
Restore	Restore original settings	RIGHT	Select right cursor
RS232	RS232 interface	RUN	Run peak-hold
S	Siemens (conductance)	SAVE	Save current data or waveform
SETUP	System setup	Single	Single trigger
STOP	Stop peak-hold function	TIME	Time base
TRIG	Trigger	TRMS	True RMS
UPPER	Select upper cursor	V	Voltage
VOLT	Voltage, input sensitivity	μF	Micro Farads (capacitance)
μs	Microsecond	μS	Micro Siemens (conductance)

Ω	Ohm	ΔV	Volt difference
Δt	Time difference	▲ ▼	Moving up/down
◀ ▶	Moving left/right	■	Battery level
┌ └	Trigger slope: rising edge/ falling edge	🔊	Beep (continuity)
🔌	AC adapter	➔	diode
🔗	External clamp head measurement	🔌	The power switch and automatic shutdown before 1 minute prompt
💻	PC Communication	⚡ !	Safety warning (harmful or limit of voltage, current hint)

ADP mode (extended measurement function option, please get LianXiBen company product service center),

ADP measurement is adopted additional extension adapter measuring a measurement model. In ADP mode can measure temperature, transistor amplifier and can use multiple parameters such as external current head measuring ac 40A plier 400A ~ within the scope of large current.

ADP mode must be required access tests accessories ,

Not any voltage signal measurement .

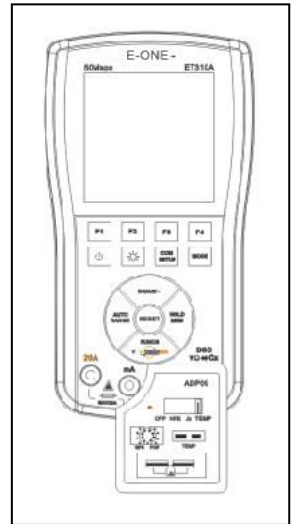

ADP measurement menu:

Centigrade	Fahrenheit	Transistor magnification	External current clamp head
°C	° F	hFE	🔗
F1	F2	F3	F4

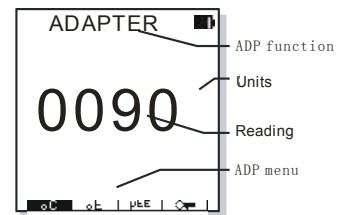

1. Will test instrument is the polarity of attachment insert V socket and negative polarities COM port;

2. press FUNCS. select  , Selected, screen

Top screen will appear in the ADAPTER, tip has external Adapter measurement function expansion .

- Press F1 (degrees Celsius) into temperature measurement
- Press F2 (° F) into Fahrenheit temperature measurement
- Press F3 keys (hFE) into transistor hFE measurement
- Press the F4 keys () Into the external exchange 40A / 400A plier head current measurements

3. Temperature measurement, labeled in annex TEMP position insertion standard temperature sensor (k), negative polarities attention on the attachment to the TEMP position, strike switch by measuring the sensor probe contact surface temperature of liquid or temperature display, read (Celsius or Fahrenheit temperature). Temperature sensor probe not contact with more than 36VDC or 25VAC safety voltage voltage .

4. Transistor amplifier, according to multiple measurement of polarity transistor by its foot type PNP transistor insertion NPN or corresponding ebc jacks, annex clicked, switches to display value for hFE magnification of the transistor. No show or improper readings, may be wrong choices, type transistor polarity transistor or damage .

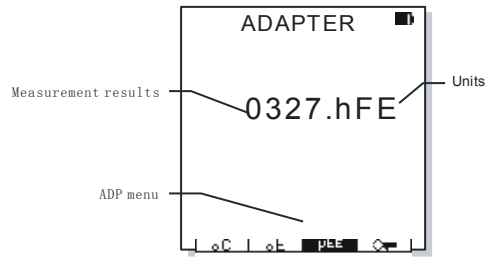
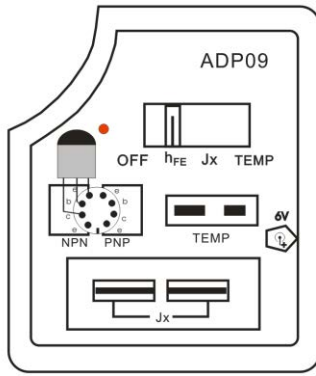

5. External clamp head measuring ac current, external clamp head (option) connections of banana plugs instrument is the V socket and negative polarities of polarity COM port, According to the measuring current size selection clamp 40A head, check or 400A RANGE for the screen display, 0 current 400.0 40.00 per day or when 00.00 readings for A 000.0 or AUTO, press A button to display access-list/head with pliers. RANGE Push open handle, open clamp head plier, will be measured in which the current wire screen display, read.

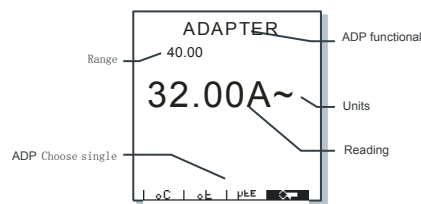
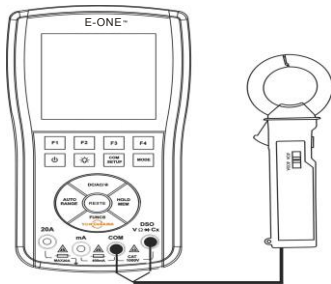

6. Crystals test, will be measured crystals Jx insert aperture, Jx position switches to strike accessories, press MODE key choice and wave form (DSO) MODE, then press AUTO/access-list keys, use the function of automatic Settings to DSO waveform stability. After the show, with stable waveform can check crystals work load waveform and lower frequency value namely screen for ZhenQi crystal oscillator frequencies. 32kHz 10MHz ~ (test scope, measured by crystal frequency than 10MHz will display error data).

If no readings may be, A bad contact, crystals, B ZhenQi frequency deviation, wafer measuring range, C, crystals damage.

7. ADP accessories and the use of power supply, open the lid, annex 9V battery pack into laminated batteries. When using, accessories, choose the switch on the panel Jx/TEMP/hFE any function, control screen display F1 ~ F3 function and accessories (except Jx choice).

8. ADP05 choose high attenuation accessories, can extend DC10000V voltage measurements.

NOTE!	<ul style="list-style-type: none"> • Before the measurement, accessories for power switch, if not hFE, may lower cell voltage battery, or bronze V please replace or install new battery. • After use, will strike switch to OFF position, avoid long-term attachment on battery power cause.
--------------	---

MAINTENANCE

Keep the instrument dry.

If it gets wet, wipe it off.

Use and store the instrument in normal temperature.

Temperature extremes can shorten the life of the electronic parts and distort or melt plastic parts.

Handle the instrument gently and carefully.

Dropping the instrument can damage the electronic parts or the case.

Keep the instrument clean.

Clean the Meter with a damp cloth and a mild soap. Do not use abrasives, solvents, or alcohol.

Fuse replacement.

1. Disconnect and remove the test leads and turn off the power. Remove the rubber holster (if it is installed).

2. Remove the two rear case screws and Lift the rear case far enough to gain access to the fuses located opposite the input terminals.
3. Replace the blown fuse: 250V/500mA for the 400mA range.
4. Replace the rear case and secure with two screws.

WARNING	Disconnect the probe from any source of voltage before removing the rear case and Do NOT perform measurements unless the rear case is closed. Do not touch or attempt to remove any other components in the instrument.
----------------	---

CAUTION	Always replace fuses with the same size and value (250V/500mA).
----------------	---

The complete and choose a meter

Meter standard accessories: ET310B host machine, low noise BiaoBi test for power adaptor, DC6V 500mA/a, portable bag product manuals, Oxford, a book.

Options: ADP09 extended measurement accessories (temperature/triode hFE/crystals, including temperature probe measurement 9V battery, and operation instruction),

P C communication options: PC - 31 suites (including USB cables, and software, adapter drive disc)

Other instrument/accessories (option),

ADP03A exchange clamp head transmitter

ADP03A for 40A / 400A exchange clamp head, output and measured by transmitter current corresponding exchange 40mV / 40A and 400mV / 400A signal, using a multimeter to function, choose the clamp, head ADP AUTO pressing to display range and key plier, head range readings for the measurement result.

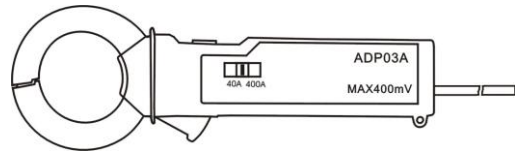

Other multimeter with manual range 200mV (400mV) ac voltage measurement gear, display voltage values measured by corresponding result.

ADP05 high attenuation probe

ADP05 adopts the high impedance voltage 15000V than with a multimeter input resistance, now constitute pressure to 10000V dc voltage measurement range. When measuring instrument for 4000V manual range, X10 readings.

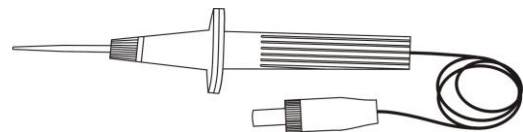

ADP08 transition joints (including high-frequency shielded test line)

In the wave function condition, using a multimeter to the test form is great wave test thoroughly eliminate interference. To adapt to the need of high quality test, user can choose ADP08 line and test frequency shield conversion connector.

ADP08 transition joints end insert plug, another end connection multimeter high-frequency shielding test line socket. When measuring high frequency signal, especially important.

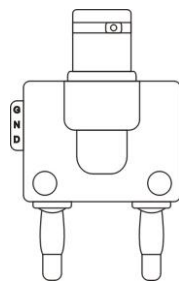

TROUBLESHOOTING

If you experience a problem with the instrument, try the corrective actions below before concluding that the instrument needs repair.

The screen remains blank or the buttons do not respond:

1. No power supply. Make sure the battery is not exhausted or the AC adapter is in good condition and connected properly.
2. Contrast adjustment is incorrect.
3. Press **RESET** button for at least 1 seconds.

Voltage readout does not correspond with the actual value:

1. Check the fuses to make sure that it is still good and is properly inserted.
2. The zero reference in DSO mode is not set correctly for DC measurements.
3. When measuring **RMS** in DSO mode, make sure that at least 1 and preferably even 2 periods are displayed.

No signal on the oscilloscope display:

1. Time base setting is in the wrong position. Try auto-setup mode.
2. The instrument is in the **HOLD** or "Single" mode
3. The trigger level is not reached (choose "Auto" mode)
4. Vertical position is wrong.
5. The input signal is too high, change the volt/div or Try AUTOSET.

Incorrect frequency readout in DSO mode:

1. An incorrect time/div. setting has been chosen (start at 2.5 μ s/div).



1141 Budapest, Fogarasi út 77. 1095 Budapest, Mester utca 34.
Tel.: *220-7940, 220-7814, 220-7959, Tel.: *218-5542, 215-9771, 215-7550,
220-8681, 364-3428 Fax: 220-7940 216-7017, 216-7018 Fax: 218-5542
Mobil: 30 531-5454, 30 939-9989 Mobil: 30 940-1970, 20 949-2688

E-mail: delton@delton.hu Web: www.delton.hu

www.holdpeak.hu